

COLUMN GLASS RAILINGS 514.63 - 2

22.02.2018



Glass thickness
1:5

U rubber profile

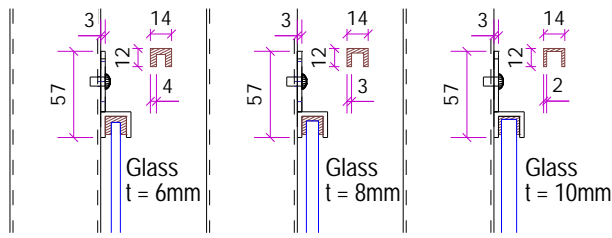

Front view

Side view

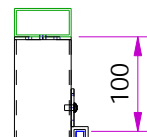
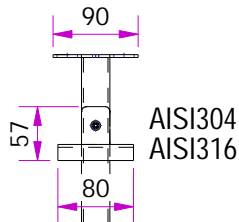

AISI304
AISI316

STEEL TUBE 60x30x2

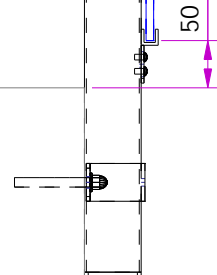
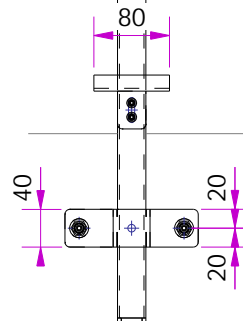

Hole diameter
13mm suitable for
Kzn concrete bolt,
anchor M8 or
chemical anchor

AISI304
AISI316

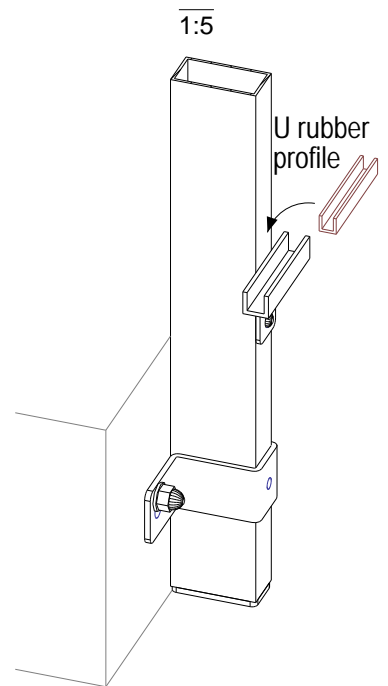
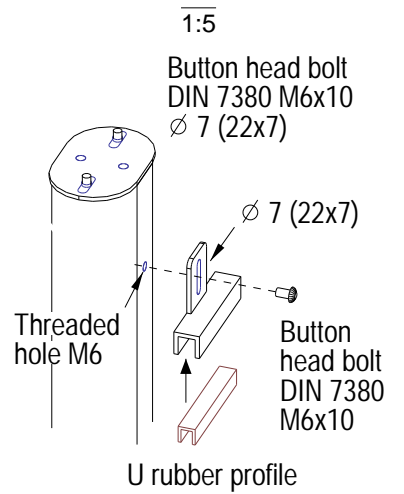
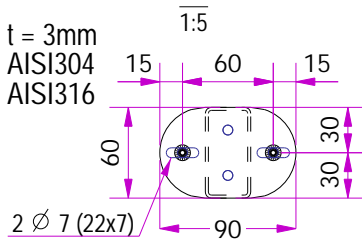
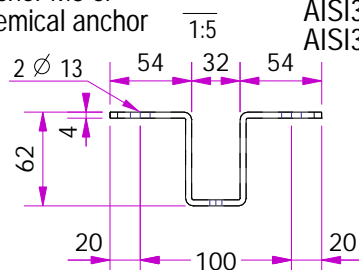

• staBico •

Producer: STABICO OU

Tallinn, Estonia

Tel: +372 555 17 989

e-mail: stabico@stabico.ee

Web: www.stabico.ee