

WORK SHEET

TERRACE BORDER COLUMNS 40x40x2

3D view

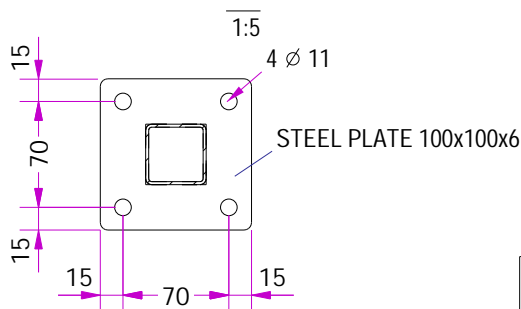
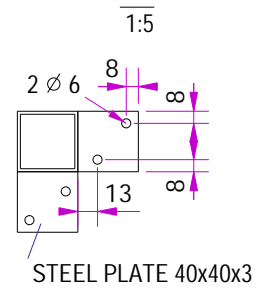
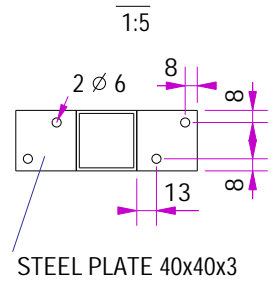
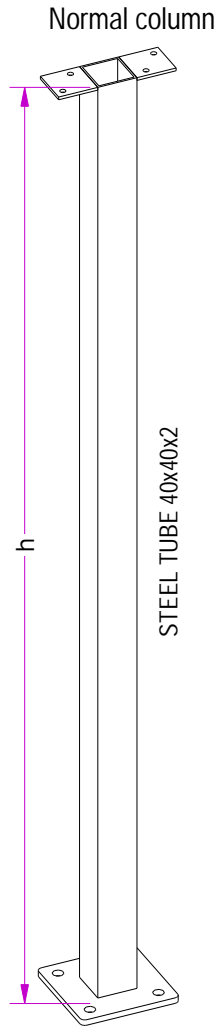
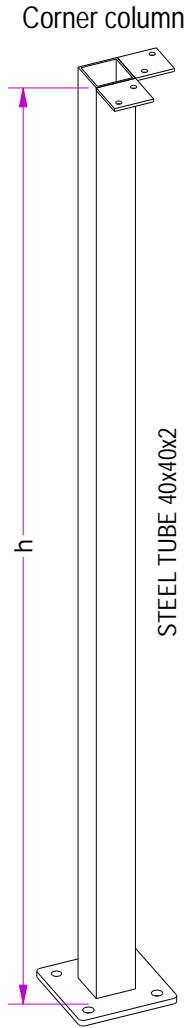
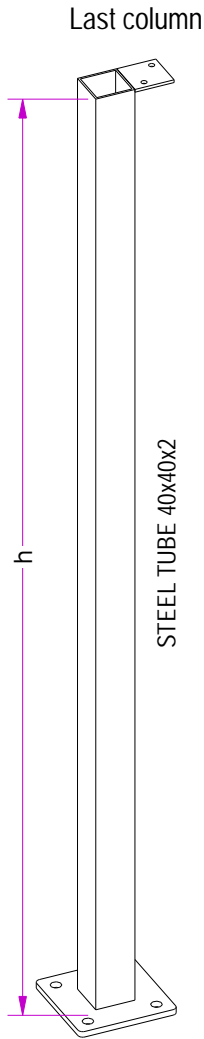
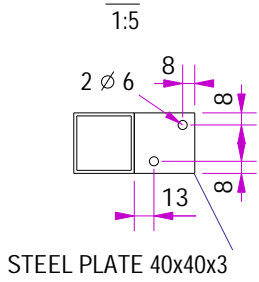

	Height h	Quantity
Corner column		
Normal column		
Last column		

Fe	Kzn	Ral

staBico

Producer: STABICO OU

Tallinn, Estonia

Tel: +372 555 17 989 e-mail: stabico@stabico.ee

Web: www.stabico.ee