

SIRGE SUPPORT
tasapinnale



LIIGENDIGA SUPPORT
trepile



LIIGENDIGA SUPPORT
HÜLSIGA trepile



VPP-42

D12x4.A2.S

PUURIN ISE



KÄSIPUU TALDRIK KANTTORULE



KÄSIPUU TALDRIK ÜMARTORULE

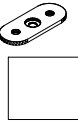

VAHEPOST

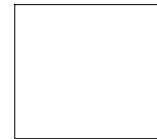

NURGAPOST

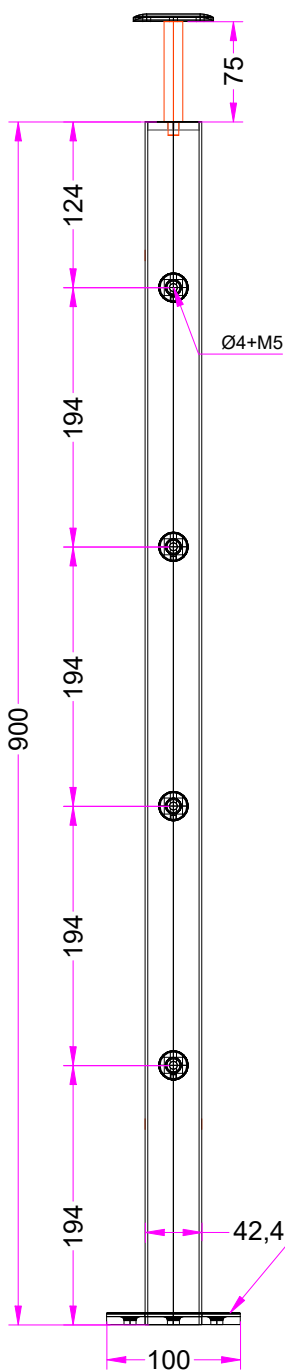
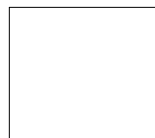

KINNISTUS LÄBI ASTME

(posti sees keevispuks M10 keermega kaasas M10x80 polt, posti all Ø50mm lahtine seib

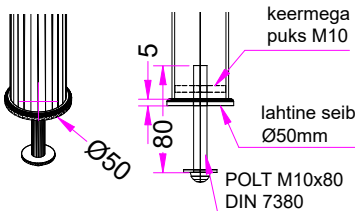

KINNITUS KÜLJELT
LÄBI POSTI

250mm+900mm standard

A-standard 30mm märgi

B-standard 150mm märgi

C-standard 70mm märgi

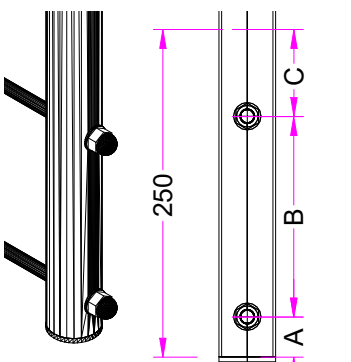

STANDARD POSTI TALLAD KAETUD
ILUKATTE PLAADIGA (tallas faasitud avad)

VÕI TRUGITUD KÕRGE KATE

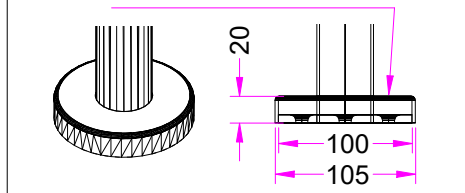

ADAPTER
tava Aisi 304
5012.42.A2.S

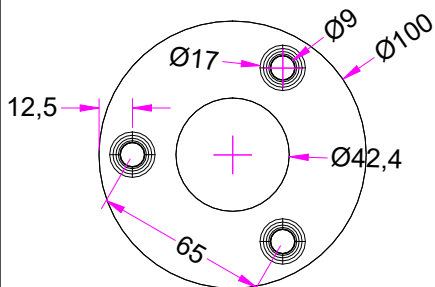
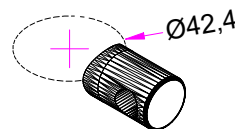

KINNITUS LÄBI
PARKETI
(kinnitusplaat väiksem d90mm ja katteplaat ülekattega d100mm jääb parketi peale)

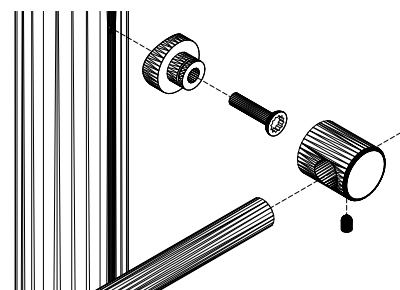
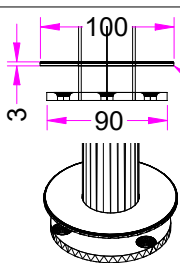

•stabiCo•

EC Certificate 1526
Factory Production Control
CE Certificate EN 1090-2
1526-CPR-1090-1.0050

Producer: STABICO OÜ e-mail: stabico@stabico.ee tel: +372 555 17 989 www.stabico.ee