

SIRGE SUPPORT
tasapinnale

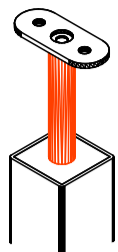

LIIGENDIGA SUPPORT
trepile

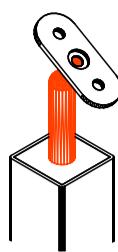

LIIGENDIGA SUPPORT
HÜLSIGA trepile

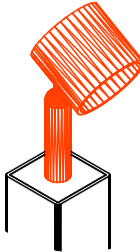

LIIGENDIGA SUPPORT
ADAPTER

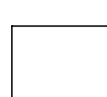
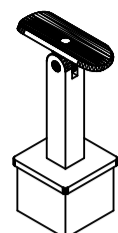

PUURIN ISE



KÄSIPUU TALDRIK KANTTORULE



KÄSIPUU TALDRIK ÜMARTORULE

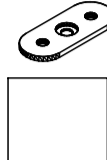

NURGAPOST

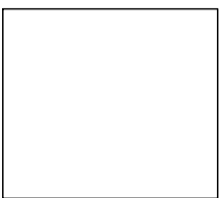

VAHEPOST

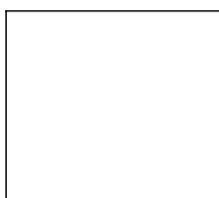

OTSAPOST

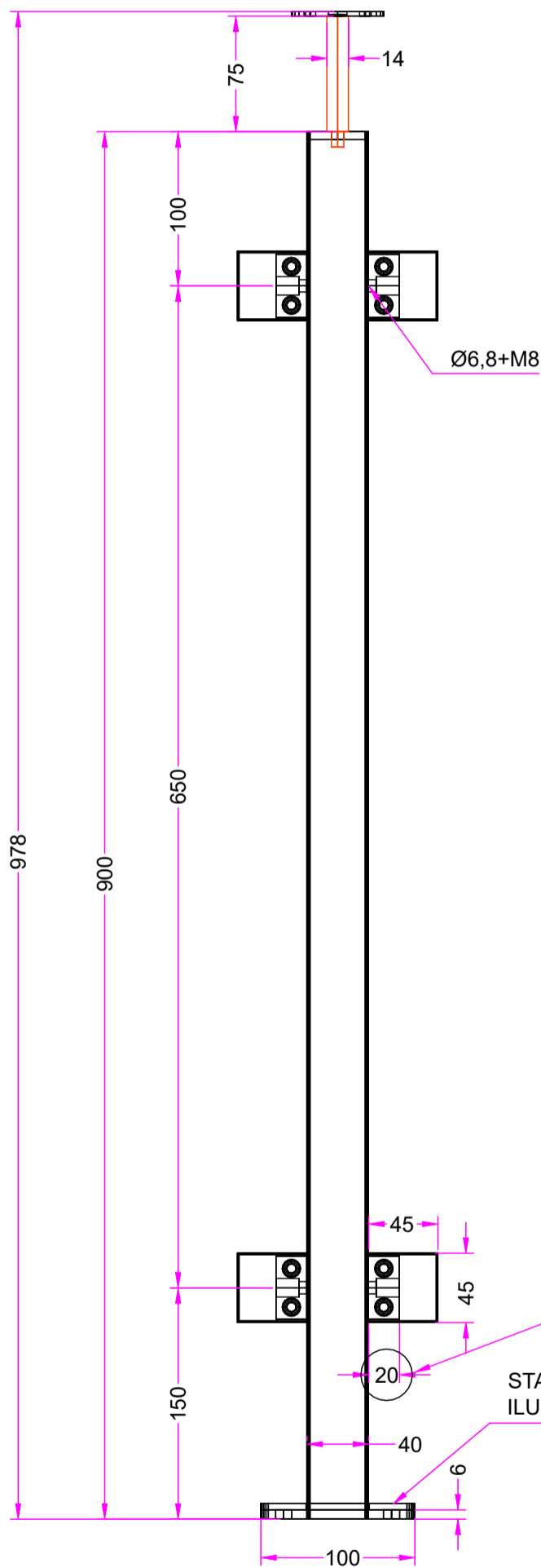

KLAASI KAUGUS POSTIST 20mm

STANDARD POSTI TALLAD KAETUD
ILUKATTE PLAADIGA (tallas faasitud D16)



TIHENDID:

6mm klaasile

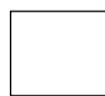

8mm klaasile



10mm klaasile



KLAMBER
SISSE
502.00.ZN.SS

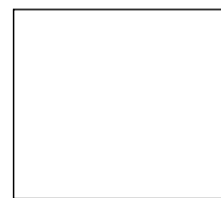

KLAMBER
VÄLJA
502.00.02.SS

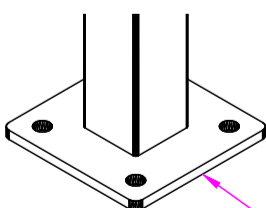
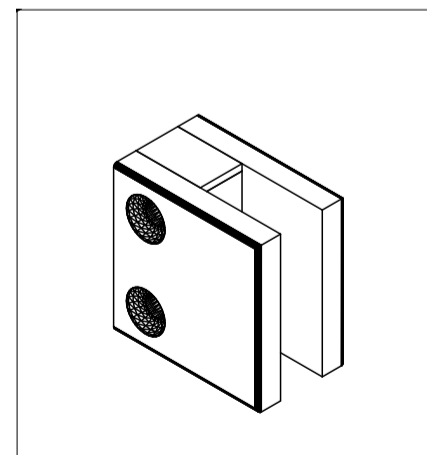
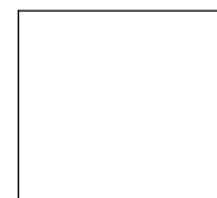

POSTI TALLAD ILMA PLAADITA

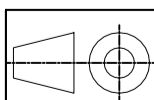
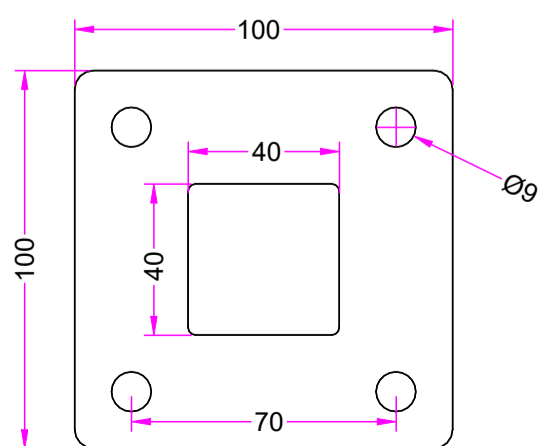

•staBico•

		•staBico•		Materjal:	
				Viimistlus:	
Mööb:	Projekti nimetus:	Ettevalm. klass: P2 (ISO 8501-3)	Keevisõmblused: a4		
Kogus:	Toote nimetus: PIIRDEPOST H=900mm (1m piirdele)	Ehitusklass: (ISO 1090) EXC 2	Geom. tolerants: -		
Joonise nr:	Joonise nimetus:	Kvalit. klass: (ISO 5817) C	Lin. tolerants: A		
Konstr.:	Kuupäev:	Tellijä:	Tähtaeg:		
Kontrollis:	Kuupäev:	Leht:			